



# PROJEKTOR LED TRACKLIGHT



## GAH

Projektor do systemu szynoprzewodowego. Oprawa produkowana jest na renomowanych marek oraz zgodnie z konfiguracją klienta. Doskonały do obiektów handlowych i wystawienniczych.

### DESCRIPTION / BESCHREIBUNG/ DANE OPRAWY

**Montaż:** Szynoprzewód.  
**Obudowa:** aluminium.  
**Kolor [C]:** biały lub czarny.  
**Optyka [A] :** Trzy kąty świecenia: 12°, 24° lub 40°

**Sterowanie:** standard ON/OFF

**Wskaźnik oddawania barw [R]:** Ra >80, Ra >90

**Barwa światła [K] :** Standard lub dedykowane dla konkretnych produktów  
 Standard:

W-2600-2700K; V-3000-3200K; D-3800-4200K;  
 A-5000-5200K; B-5700-5900K; C-6500-7000K.

Specjalne:

Mięso; Owoce i warzywa; Sery; Ryby; Pieczywo; Nabiał;  
 Alkohole; Wino; Ubrania i obuwie; Medycyna

### DIMENSION / MAßE/ WYMIARY

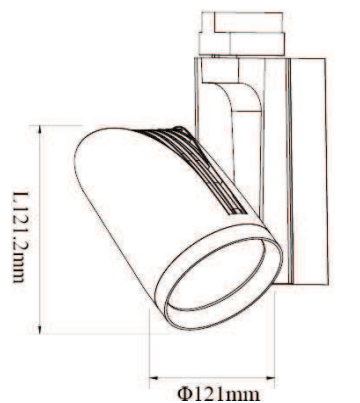

### PHOTOMETRIC [A] / PHOTOMETRIC [A] / PHOTOMETRIC [A]

#### COB 30W 12°

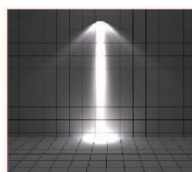
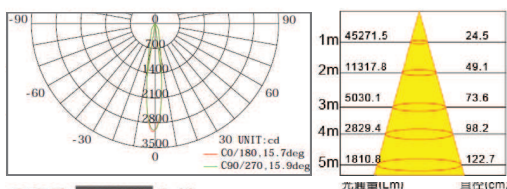

#### COB 30W 24°

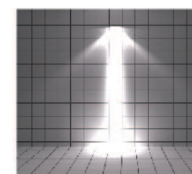
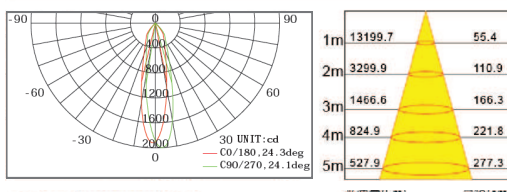

#### COB 30W 40°

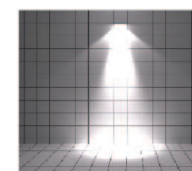
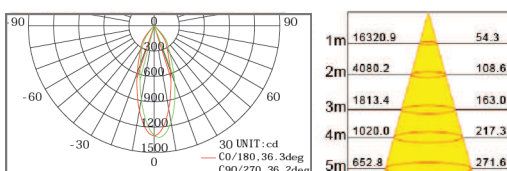

Tolerancja strumienia świetlnego +/- 10%

### COLOUR [K] / FARBTEMPERATUREN [K] / BARWA [K]

#### STANDARD

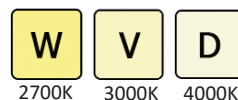

#### SPECIAL

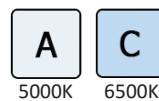

### INDEX SYSTEM

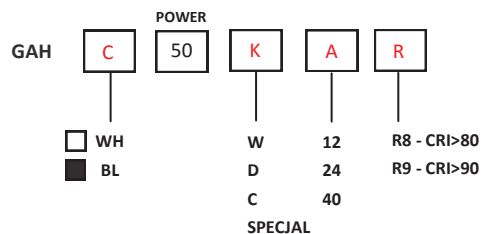

| GAH 12°     |       |              |     |       |
|-------------|-------|--------------|-----|-------|
| Index       | Power | Flux         | A   | R     |
| GAHC50W12R8 | 50W   |              | 12° | RA>80 |
| GAHC50D12R8 | 50W   | 4000-5000 lm | 12° | RA>80 |
| GAHC50C12R8 | 50W   |              | 12° | RA>80 |
| GAHC50W12R9 | 50W   |              | 12° | RA>90 |
| GAHC50D12R9 | 50W   | 3500-4500 lm | 12° | RA>90 |
| GAHC50C12R9 | 50W   |              | 12° | RA>90 |

| GAH 24°     |       |              |     |       |
|-------------|-------|--------------|-----|-------|
| Index       | Power | Flux         | A   | R     |
| GAHC50W24R8 | 50W   |              | 24° | RA>80 |
| GAHC50D24R8 | 50W   | 4000-5000 lm | 24° | RA>80 |
| GAHC50C24R8 | 50W   |              | 24° | RA>80 |
| GAHC50W24R9 | 50W   |              | 24° | RA>90 |
| GAHC50D24R9 | 50W   | 3500-4500 lm | 24° | RA>90 |
| GAHC50C24R9 | 50W   |              | 24° | RA>90 |

| GAH 40°     |       |              |     |       |
|-------------|-------|--------------|-----|-------|
| Index       | Power | Flux         | A   | R     |
| GAHC50W40R8 | 50W   |              | 40° | RA>80 |
| GAHC50D40R8 | 50W   | 4000-5000 lm | 40° | RA>80 |
| GAHC50C40R8 | 50W   |              | 40° | RA>80 |
| GAHC50W40R9 | 50W   |              | 40° | RA>90 |
| GAHC50D40R9 | 50W   | 3500-4500 lm | 40° | RA>90 |
| GAHC50C40R9 | 50W   |              | 40° | RA>90 |

